

CycloBarrier® Storm Resistant Mobile Solar Mounting System

Introducing the CycloBarrier® Sentinel Mobile Solar Mounting System (Top Deployment, Carport Application)

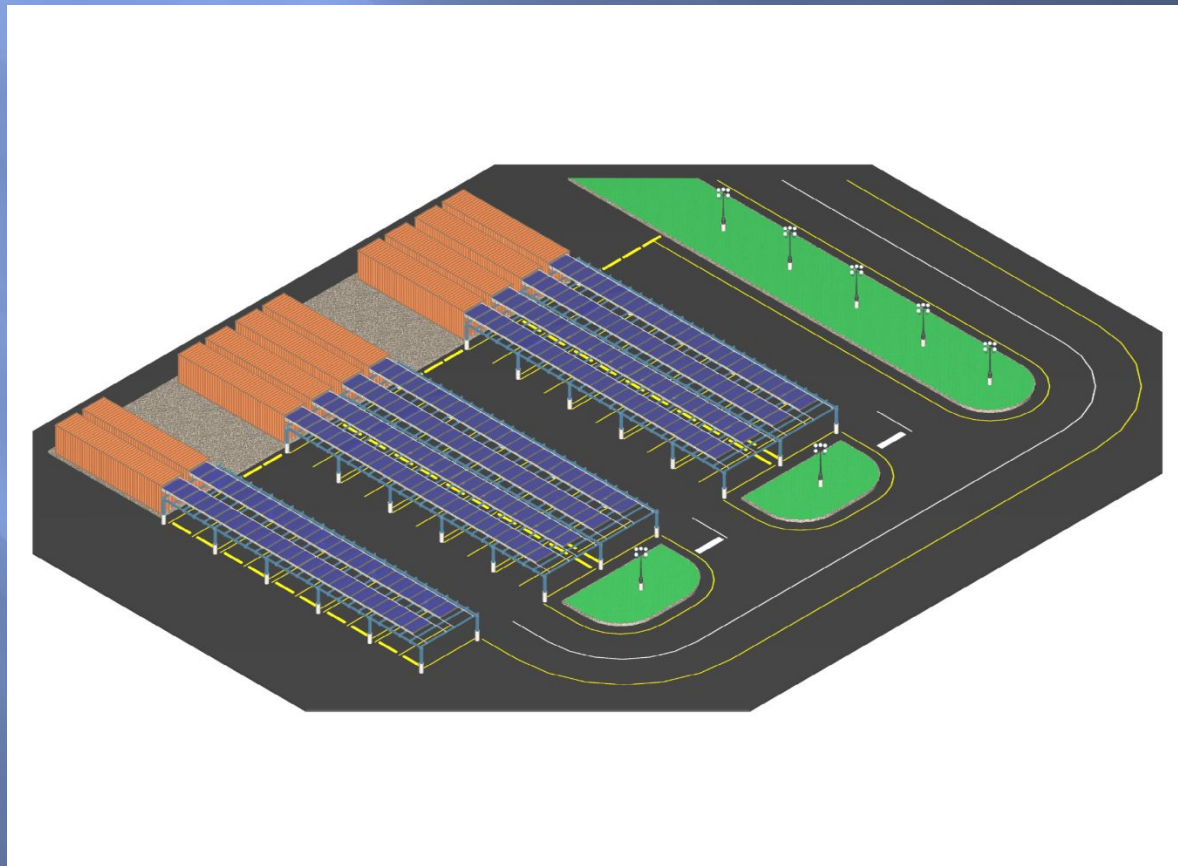

CycloBarrier® Storm Resistant Mobile Solar Mounting System

Introducing the CycloBarrier® Sentinel Mobile Solar Mounting System (Bottom Deployment, Ground Application)

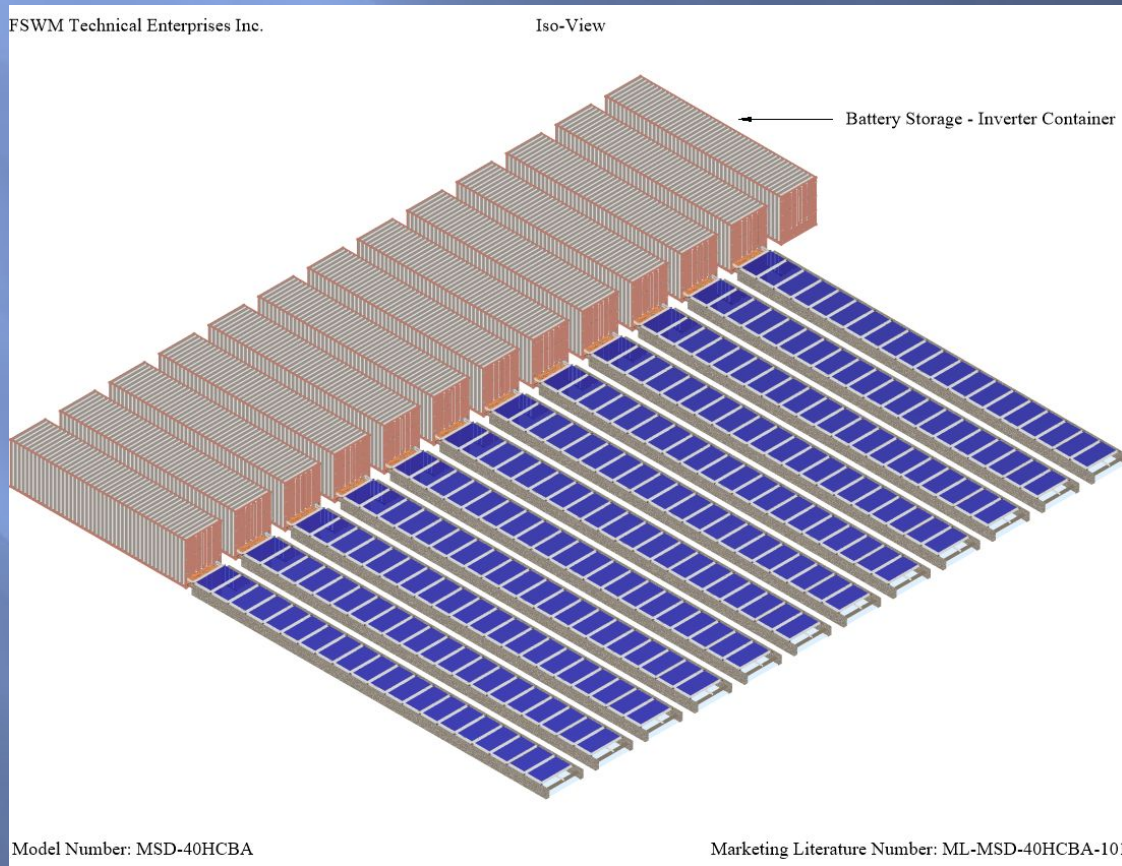

CycloBarrier[®] Storm Resistant Mobile Solar Mounting System

Introducing the CycloBarrier[®] Sentinel Mobile Solar Mounting System (Top Deployment, Bunker Application)

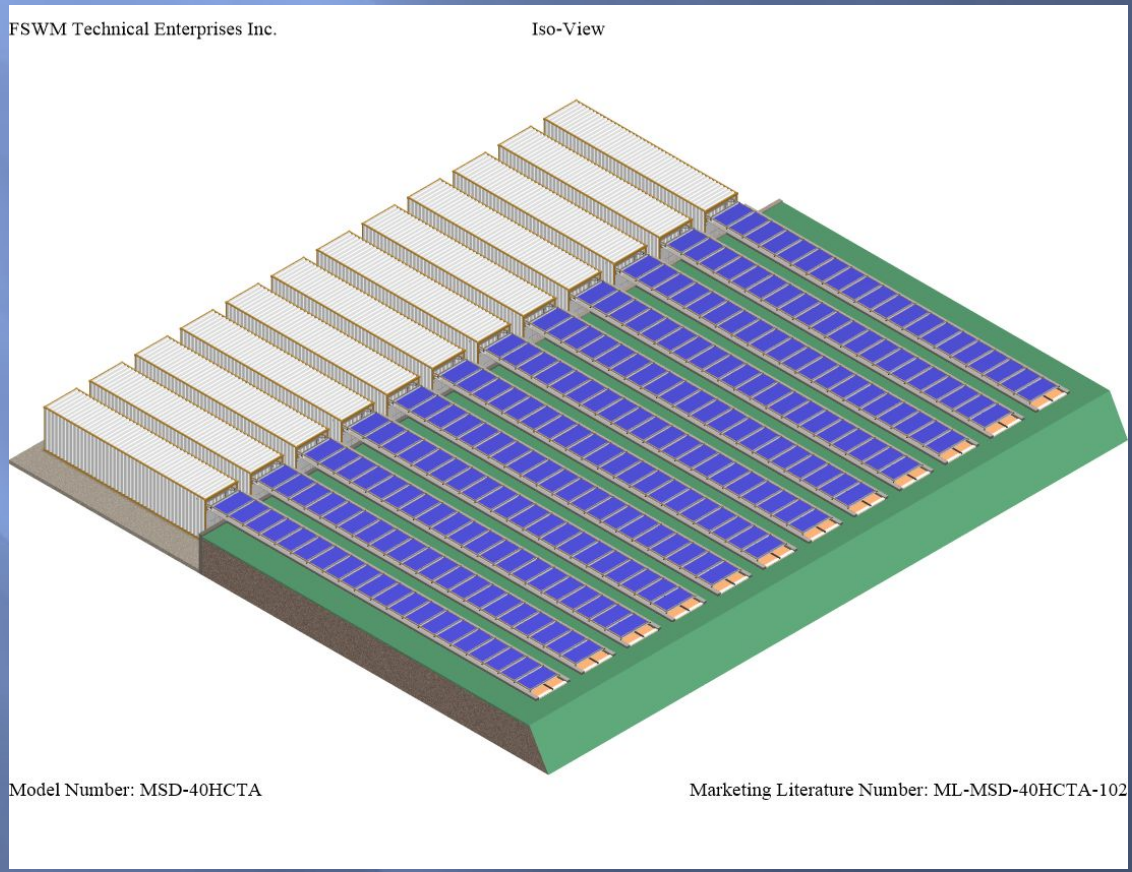

CycloBarrier® Storm Resistant Mobile Solar Mounting System

Introducing the CycloBarrier® Sentinel Mobile Solar Mounting System (Top Deployment, Bunker Application, Side View)

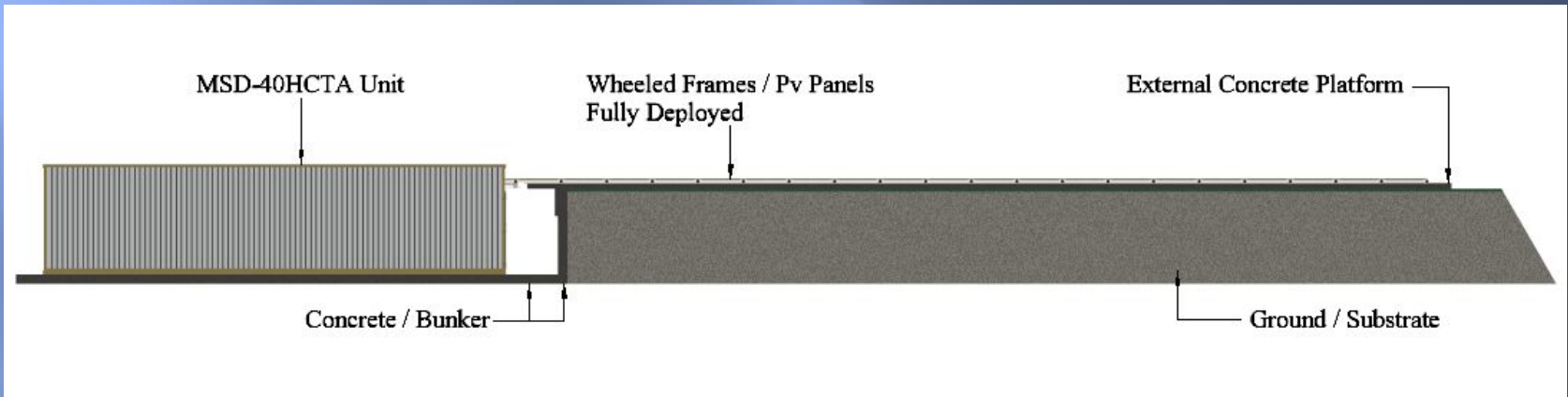

CycloBarrier® Storm Resistant Mobile Solar Mounting System

Introducing the CycloBarrier® Sentinel Mobile Solar Mounting System (PV Panel and Frames)

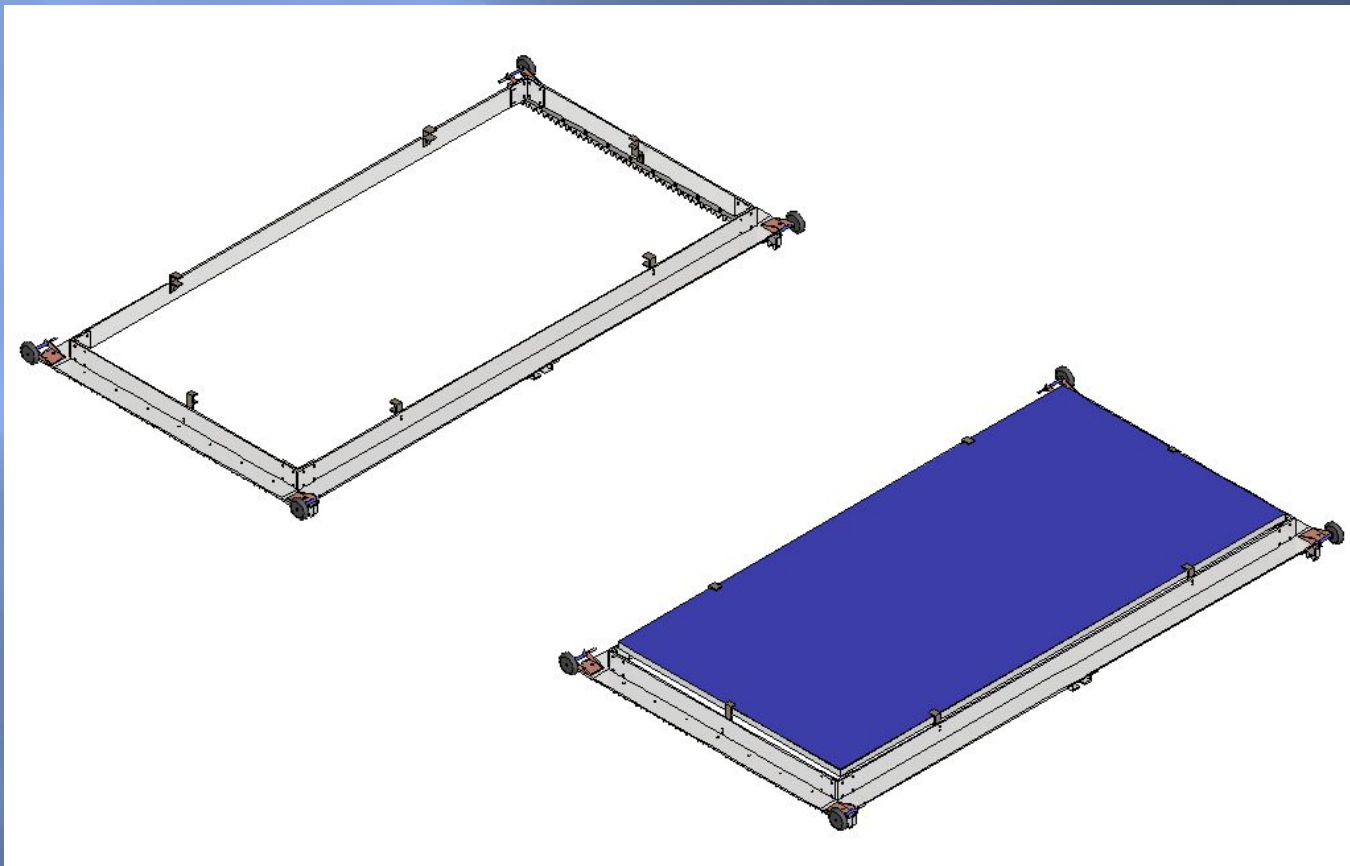

CycloBarrier[®] Storm Resistant Mobile Solar Mounting System

Introducing the CycloBarrier[®] Sentinel Mobile Solar Mounting System

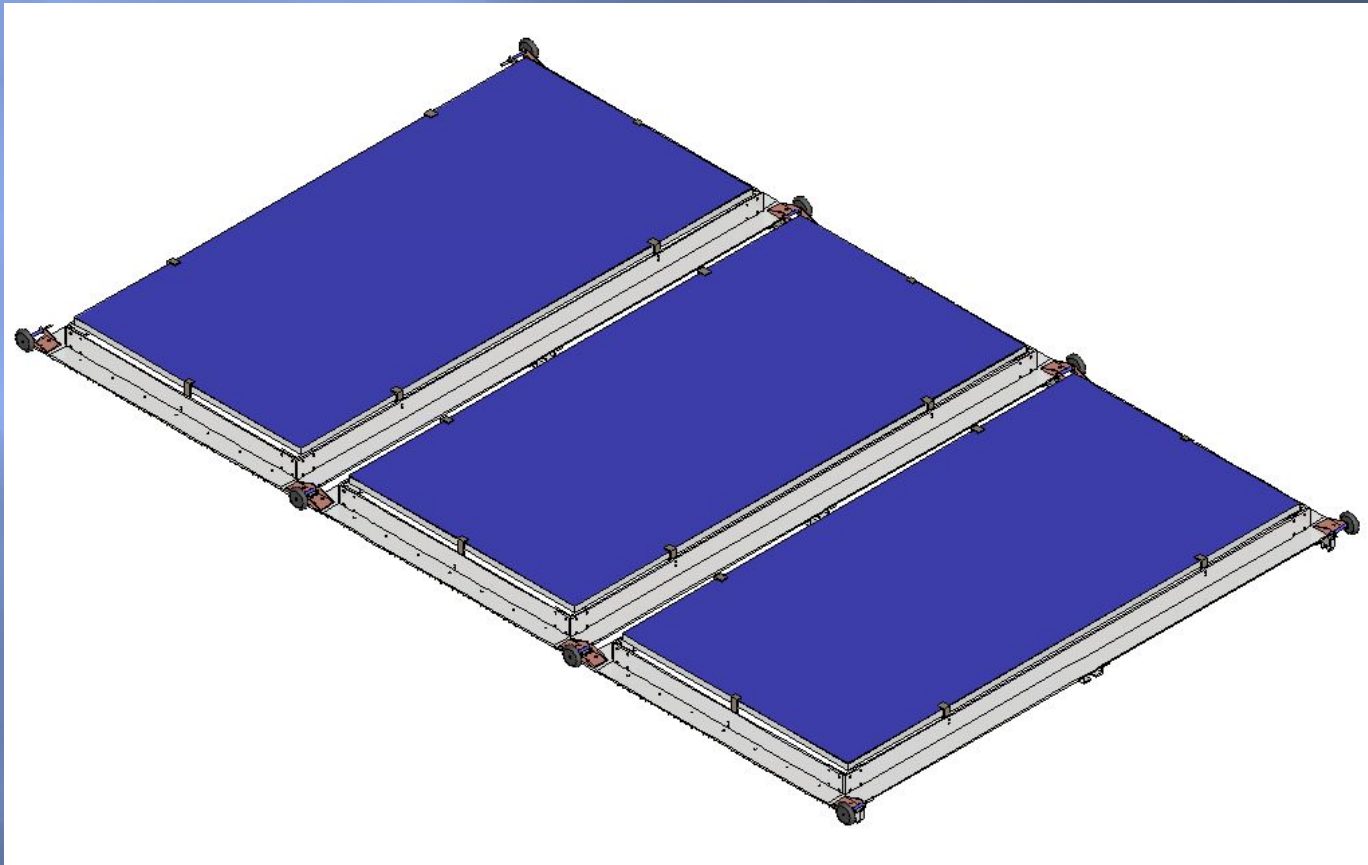

CycloBarrier® Storm Resistant Mobile Solar Mounting System

Introducing the CycloBarrier® Sentinel Mobile Solar Mounting System (Bottom Deployment, Side View)

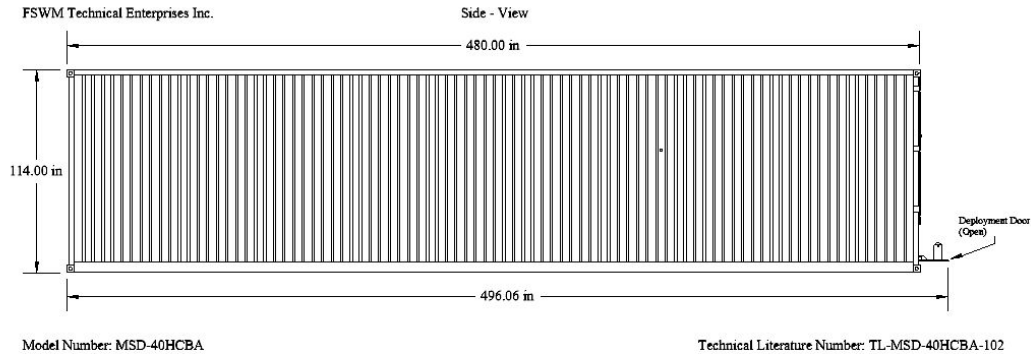

CycloBarrier® Storm Resistant Mobile Solar Mounting System

Introducing the CycloBarrier® Sentinel Mobile Solar Mounting System (Bottom Deployment, Side View)

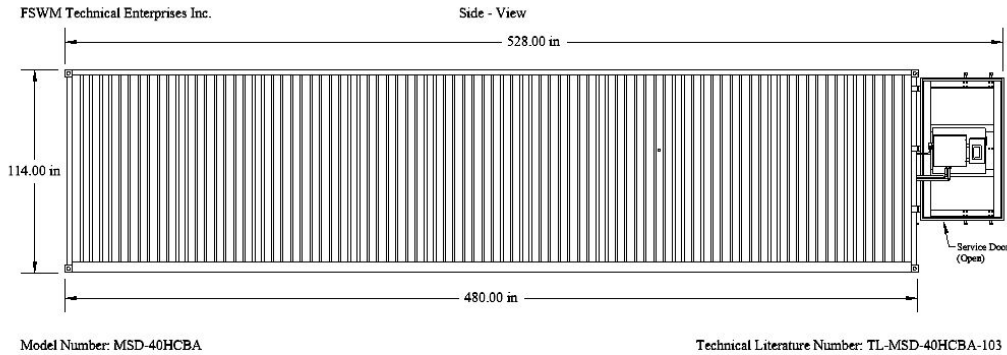

CycloBarrier[®] Storm Resistant Mobile Solar Mounting System

Introducing the CycloBarrier[®] Sentinel Mobile Solar Mounting System (Bottom Deployment, Side View 'Cut-Away')

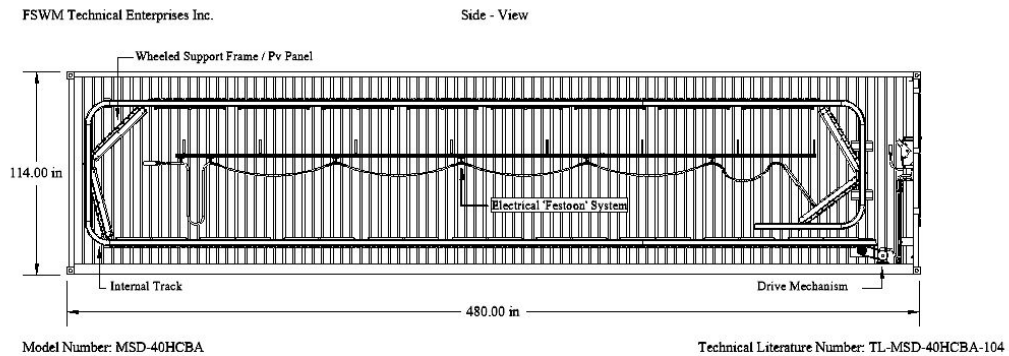

CycloBarrier® Storm Resistant Mobile Solar Mounting System

Key Unit Features

- Each Unit Securely Mounts Up To 28 Commercial Size Solar Panels
- Available up to a 25-Year 'Design Life' (Limited Product Warranty, Service at Scheduled Intervals)
- Highly Resilient, INTENDED for Application in Hurricane-Prone Regions
- Ideal For On-Site Renewable Power For Critical Facilities (Hospitals, Fire, Police, Emergency Management Facilities)
- Fully Automated Control System, < 5 Minute "Storm-Deployment" Cycle
- Modular and Scalable Design
 - Factory Produced to Customer Specification
 - Units Are Designed To Be Applied With Energy Storage (Commercial / Industrial 'Micro-Grids')
 - Individually Controlled Units Make Precise 'Curtailing' Achievable And Easy
- No Penetration Designs Available, Rapid Installation on Prepared Surfaces (12-Week Carport Installation)
- Web-Based, 'Field Control' Application Available for Owner / Operators
- Solar Panel Array Retracted When Forecasted Wind Speeds Are Excessive
- CycloBarrier Satellite-Based Control Network (Global Control Network, Subscriber Service)

CycloBarrier® Storm Resistant Mobile Solar Mounting System

THE SENTINEL MOBILE SOLAR MOUNTING SYSTEM:

- IS DESIGNED TO PROTECT UP TO 28 COMMERCIAL SIZE SOLAR PANELS IN ISO-MODAL CONTAINER UNITS
- IS INTENDED TO BE INSTALLED ON IN HURRICANE-PRONE REGIONS
- ONCE THE SENTINEL UNITS ARE SECURED ON A PREPARED SURFACE, AND FULLY CONNECTED, A STORM-HARDENED SOLAR FIELD IS THE RESULT. THIS 'MODULAR' METHOD CAN BE RAPIDLY INSTALLED.
- A UNIT WILL HAVE A USABLE / DESIGN LIFE UP TO 25 YEARS (DEPENDING ON MODEL TYPE AND WITH CORRESPONDING WARRANTY AND STIPULATIONS FOR SERVICE / MAINTENANCE).
- THE SENTINEL UNIT WILL ENABLE THE SOLAR PANELS TO SURVIVE A STORM EVENT, WITH WIND CONDITIONS UP TO CATEGORY 4 LEVEL (SAFFER/SIMPSON SCALE, DEPENDING ON MODEL AND SYSTEM SELECTED).
- ALL OF THE REQUIRED COMPONENTS TO BUILD SENTINEL UNITS ARE COMMERCIALY AVAILABLE TODAY.
- MODULAR, INDIVIDUALLY-CONTROLLED UNITS OFFER EASY AND PRECISE 'CURTAILMENT'.
- CYCLOBARRIER SATELLITE-BASED CONTROL NETWORK (GLOBAL CONTROL NETWORK, SUBSCRIBER SERVICE)